

MINOLTA

E INSTRUCTION MANUAL

MAXXUM[®]

3000i

Your new Minolta Maxxum 3000i camera is by far the world's easiest-to-use autofocus SLR camera ever. Minolta's "intelligent" automation assures unparalleled accuracy and ease of operation. You can take sharply focused, properly exposed pictures one after another and rely on your Maxxum 3000i to deliver outstanding results from one roll of film to the next.

Some of the Maxxum 3000i's most impressive features include:

- Intelligent autofocusing that responds at very low light levels and feature a wide focus area for faster, easier focusing of moving subjects.
- Intelligent exposure which uses dual-area metering system that is coupled to the auto-focus system.
- Intelligent flash to automatically activate a dedicated flash unit when flash is needed.
- Automatic film transport that makes film handling completely reliable.
- World's most compact, most lightweight AF-SLR.

The world's largest selection of autofocus system accessories is available for your Maxxum 3000i camera. Ultra-compact Maxxum Flash D-316i and D-314i are designed exclusively for the Maxxum 3000i camera. The entire system of Maxxum AF lenses can be used, including the compact AF 35-80mm and AF 80-200mm lenses. Data Back DB-3 permits imprinting of the date or time on your pictures.

We know you want to begin using your new camera right away. Before starting, please read through this manual to learn how your Minolta Maxxum 3000i operates.

TABLE OF CONTENTS

PREPARATION AND BASICS

Names of parts	2
Data panel	
Attaching the lens	6
Care of glass surfaces	
Attaching the neckstrap	8
Battery information	10
Loading the battery	
Checking the battery condition	
Cold weather operation	
Battery performance	
Automatic setting of the film speed	13
Loading film	13
OPERATING THE CAMERA	
Holding the camera	17
Viewfinder	18
Taking pictures	19
Automatic film rewind	21
Manual start of film rewind	
Using flash	23

FOCUS

Autofocus	24
Focus hold	
Manual Focus	25
Special situations	26

EXPOSURE MODES

Program mode	27
High-speed program mode	28

ADDITIONAL INFORMATION

Main switch	29
Audible signals	30
Self-timer operation	30

ACCESSORIES	32
------------------------------	----

TROUBLESHOOTING GUIDE	36
--	----

TECHNICAL DETAILS	38
------------------------------------	----

CARE AND STORAGE	41
-----------------------------------	----

Names of parts

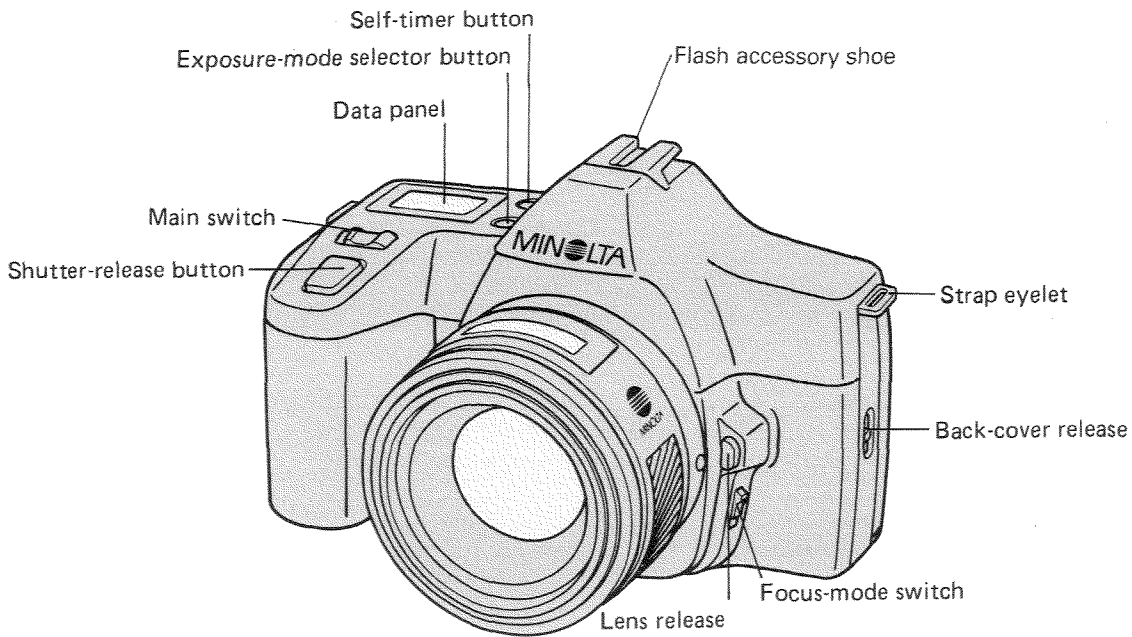

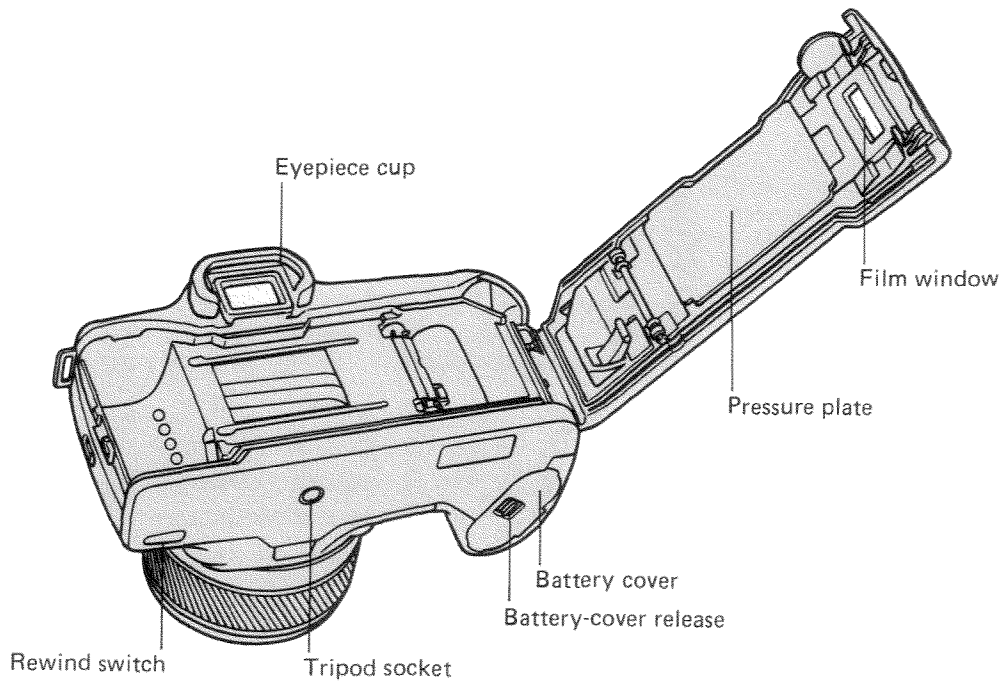

Data panel

- A. Program exposure mode
- B. High-speed program exposure mode
- C. Frame counter
- D. Film-transport signals
- E. Film-cartridge symbol
- F. Self-timer indicator
- G. Battery condition indicator

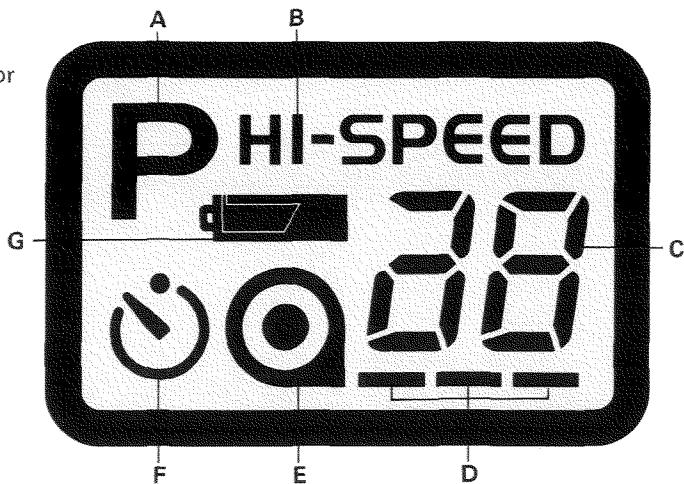

IMPORTANT INFORMATION

The Minolta Maxxum 3000i camera is designed to offer innovative functions and performance through the combination of the camera body, Maxxum AF lenses, Minolta Maxxum Flash units, and other accessories distributed by Minolta. We thus caution users that the attachment or use of incompatible lenses, flashes, and accessories may result in unsatisfactory performance or damage to the Minolta Maxxum 3000i camera. To obtain optimum performance throughout the life of your Minolta Maxxum 3000i camera, we recommend that you use only lenses, flashes, and other accessories distributed or licensed by Minolta for the Maxxum 3000i camera.

PREPARATION AND BASICS

Attaching the lens

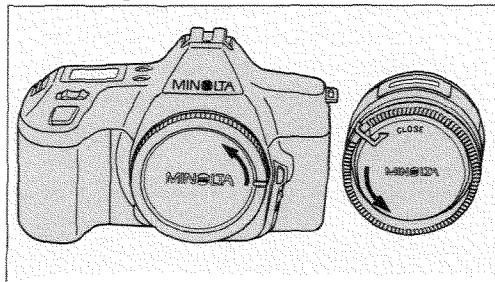

To attach

1. Remove body cap and rear lens cap as shown.

- When attaching or removing lenses, never touch anything inside the camera, especially the lens contacts or mirror.
- To protect the lens contacts and elements, attach the lens caps whenever the lens is not in use.

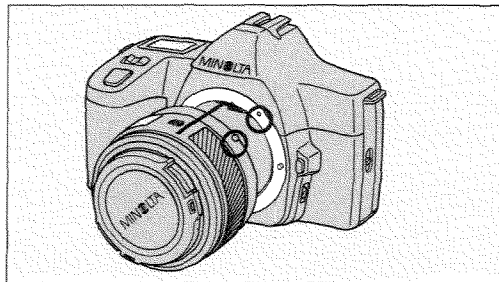

2. Align red bead on lens barrel with red dot on camera's lens mount.

Insert lens bayonet into mount and turn lens clockwise until it locks in place with a click.

If lens is not attached properly, frame counter shows "--" when camera is switched on.

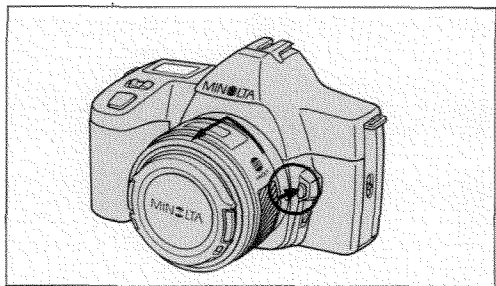

To remove:

1. While pressing lens release, turn lens counterclockwise as far as it will go, then lift lens out of mount.
2. Attach another lens or the body cap to prevent dust from entering the camera.

Care of glass surfaces

- Never touch lens elements or the camera's eyepiece with your fingers. If the lens becomes dirty, clean it gently with a lens brush. Only if necessary, moisten a sheet of lens tissue with one drop of lens-cleaning fluid. Then, starting at the center and using a circular motion, lightly wipe the surface of the lens.
- Never lift the mirror or touch its surface, as this may impair its alignment. Dust specks on the mirror's surface will not affect exposure or picture quality. If they are annoying, the camera can be cleaned at an authorized Minolta service facility.

Attaching the neckstrap and eyepiece cap

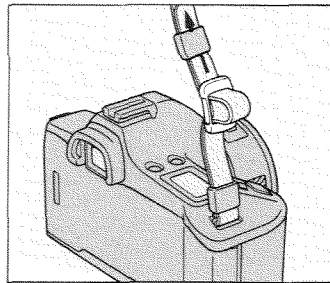
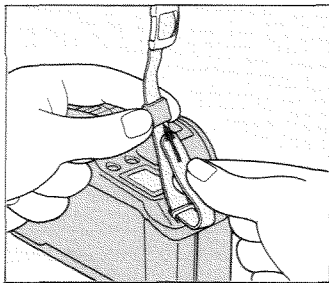
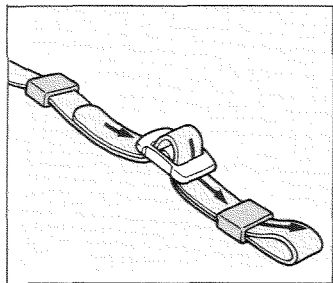

A neckstrap is supplied with your Minolta Maxxum 3000i. Attach it to the camera as shown above.

An eyepiece cap is also supplied and can be slipped onto the neckstrap to keep it handy for use.

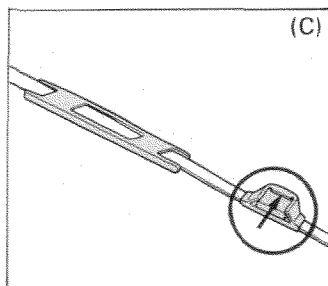
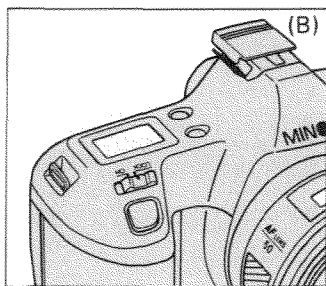
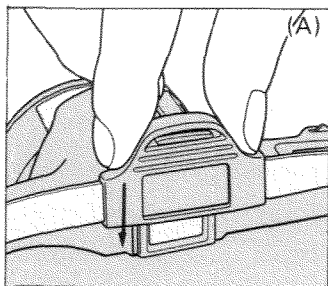

The eyepiece cap slides over the eyepiece frame to prevent stray light from entering the eyepiece and affecting exposure. It should be used whenever the eyepiece is not shielded by your head, as when using the self-timer. To attach the eyepiece cap, first remove the eyepiece cup, then slip the cap over the frame (A).

An accessory shoe cap is supplied that slips into the accessory shoe to protect the contacts from dust and grime (B). When using a flash unit, slip the accessory shoe cap into the eyepiece cap (C).

Battery information

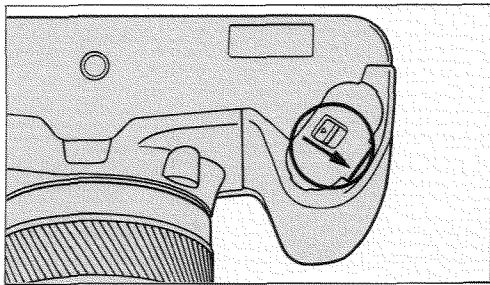

The Minolta Maxxum 3000i uses a 6-volt 2CR5 lithium battery. This battery supplies power for all camera operations, including film winding, autofocusing, and exposure control.

Power for Maxxum Flashes D-316i and D-314i is supplied by the camera's battery. Refer to the flash's instruction manual for more information.

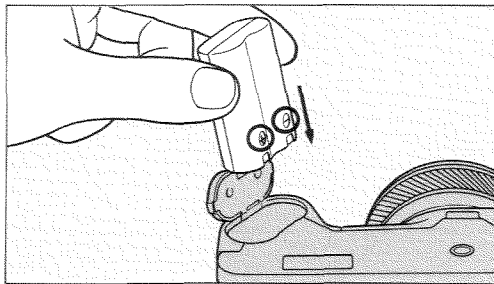

Loading the battery

1. With main switch at LOCK position, slide battery-cover release in direction shown to open battery cover.
 2. Insert the 2CR5 lithium battery as shown above, then snap battery cover closed.
- Before inserting, wipe battery terminals with a dry cloth to ensure proper contact.

Checking the battery condition

Each time you slide the main switch from LOCK to ON position, the camera automatically checks the battery's condition:

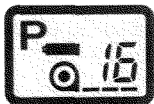

Full-battery symbol appears for five seconds when power is sufficient.



Low-battery symbol appears for five seconds: Power is sufficient but getting low—**keep a fresh battery handy.**



Low-battery symbol blinks: Camera can be operated, but **the battery should be changed.**



Only low-battery symbol blinks or no indications appear and shutter cannot be released: Power is too low for normal operation—**change battery immediately.**

NOTES

- Do not mishandle the battery. Do not attempt to disassemble, recharge, or short out the battery, or subject it to high temperatures or fire. The battery may explode or cause burns.
- Read and follow all warnings and instructions supplied by the battery manufacturer.
- Keep battery away from young children.

Cold-weather operation

Lithium batteries provide excellent performance in cold weather. However, if you plan to shoot many rolls of film outdoors at temperatures at or below 32°F (0°C), we recommend that you carry the camera inside your coat to keep it warm when not taking pictures. You may also wish to carry a spare battery in a warm pocket, so that you can change the battery, if necessary. Do not discard a cold battery. After it warms up, its capacity will be restored.

Battery Performance

The 6-volt 2CR5 lithium battery should provide sufficient power for shooting up to 55 rolls of 24-exposure film without flash, and up to 25 rolls of 24-exposure film using flash D-314i on 50% of the exposures.

These figures are based on Minolta's standard test method using a fresh battery at 20°C (68°F). Actual battery performance will depend on how you use your camera.

Automatic setting of the film speed

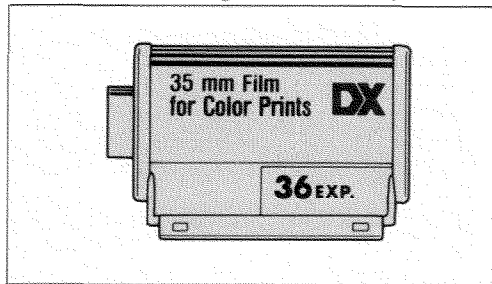

We recommend using ISO 32-3200 DX-coded films since the camera sets the film speed automatically for these films. If you use other types of film, beyond this ISO range or not DX-coded, the film speed will be set at ISO 100.

- DX-coded films have "DX" printed on their film cartridges and film boxes.

Loading film

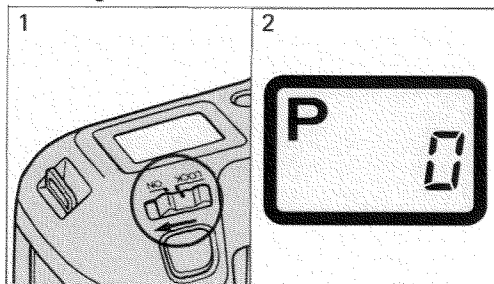

1. Set the main switch to ON position.
2. Check the frame counter. When the frame counter shows "0", it is safe to open the back cover.
 - If the frame counter shows any number besides "0", film is loaded in the camera.
 - You can also check the film window to see if film is loaded.
 - Refer to page 22 for instructions to rewind a partially exposed roll of film.

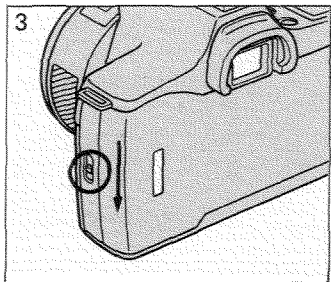

3. Open the back cover by sliding the release downward.

- Always load film in subdued light or at least shaded from direct sunlight.
- When you load film for the first time, remove and discard the protective plastic cover which is attached to the pressure plate.

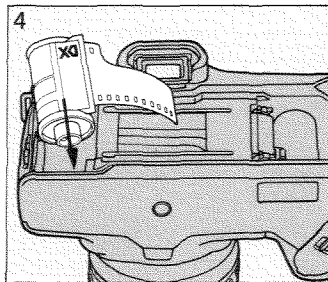

4. Place film cartridge into film chamber as shown here.

5. Extend tip of film past orange mark. Make sure the holes in the lower edge of the film engage the teeth on the sprocket.

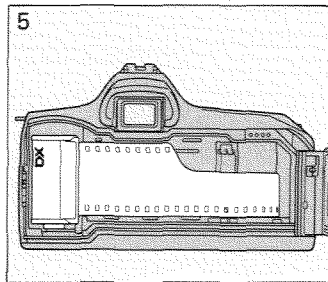

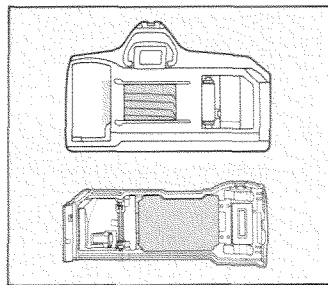
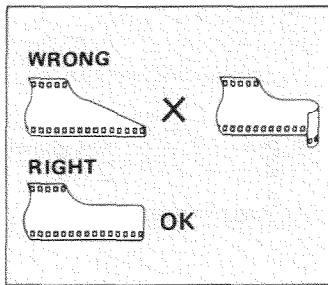
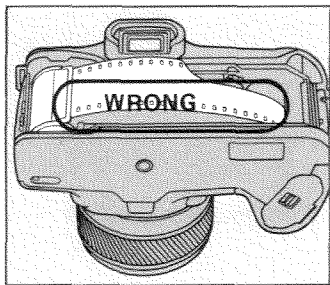

● If the film extends too far or does not lie flat, gently push the excess back into the cartridge.

● Make sure tip of the film is shaped correctly. Otherwise, the film may not wind properly.

● Do not touch any parts or areas shown in blue.

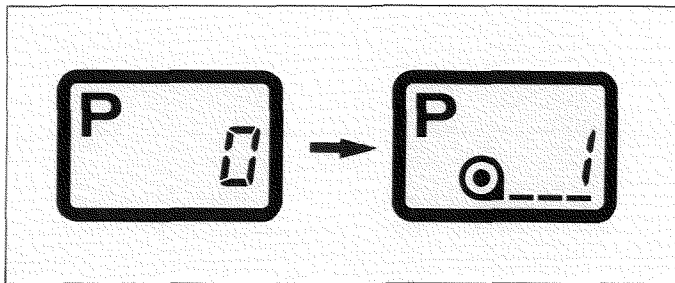
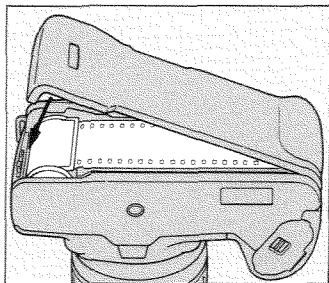

6. Close the back cover and make sure it snaps shut. The camera will automatically wind the film to the first frame. **When the film is loaded correctly, "P" will appear in the data panel.**

● The film speed for DX-coded films is set automatically. You are now ready to start taking pictures.

● If film is not loaded correctly, "□" in data panel will blink and camera will beep for one second. The shutter cannot be released and the camera will beep each time the shutter-release button is pressed. Repeat steps 3 through 6.

OPERATING THE CAMERA

Holding the camera

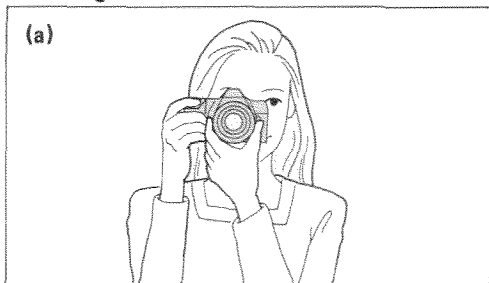

To obtain sharp, blur-free photos, hold the camera as still as possible and steady it against your face or body. Press the shutter-release button gently with a slow, steady squeeze—never a quick jab.

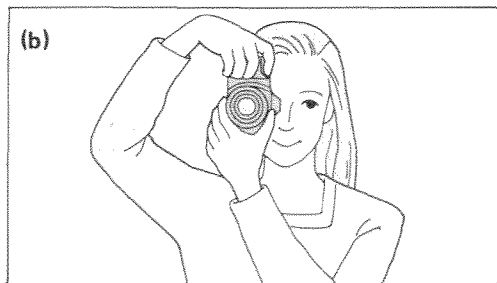

Two recommended ways of holding the camera are shown here. If you grasp the camera firmly with your right hand on its handgrip, you can shift the camera back and forth for horizontal (a) and vertical (b) pictures without removing your hands from the controls. When using autofocus, make sure you do not touch the lens' focusing ring.

Viewfinder

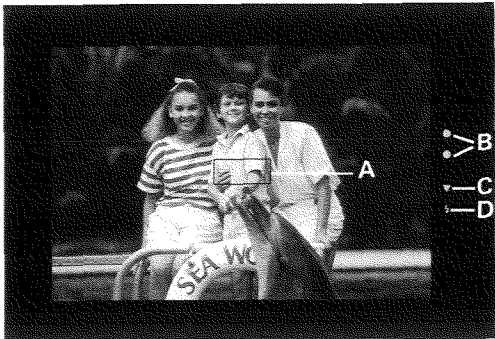

A. **Focus frame:** Center this area on your subject.

B. **Focus signals:** Green (lower) signal glows when subject is in focus. Red (upper) signal blinks when focus cannot be confirmed by camera. If using autofocus, switch to manual-focus mode.

C. **Use-flash signal.** Blinks when flash should be used, such as in low light or with backlit subjects. Continues to blink while flash unit is charging. At this time, shutter cannot be released until flash is fully charged.

D. **Flash-ready signal:** Blinks slowly when flash is charged and ready to fire. Blinks rapidly to indicate flash exposure was sufficient.

Taking pictures

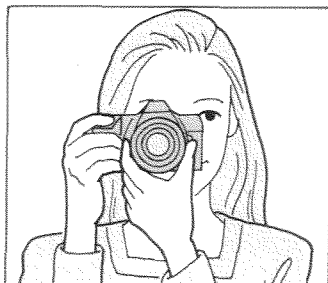
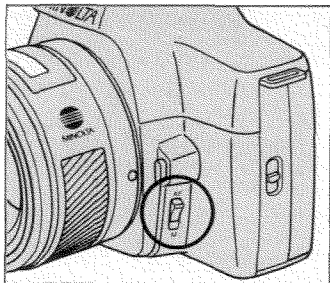
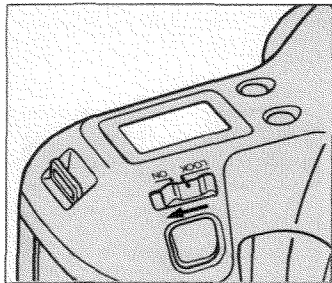

1. Slide the main switch to ON position.
2. Set the focus-mode switch to AF position for autofocus.
 - M position is used for manual focusing.
3. Hold the camera firmly with your right hand on its handgrip and support the lens with your left hand.

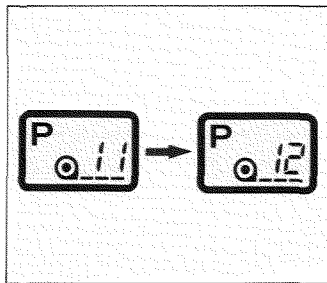
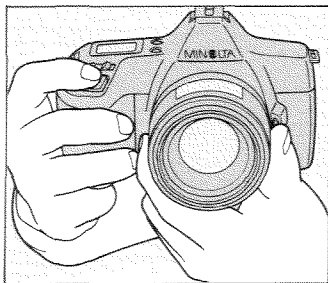

4. While looking through the eyepiece, center the focus frame on your subject and, after checking for the green focus signal, gently press the shutter-release button all the way down.

- The camera will focus automatically. The green focus signal in the viewfinder will glow when the subject is in focus. Also, the camera will beep as the subject comes into focus.
- If the red focus signal blinks, focus cannot be confirmed by the camera and the shutter will not release. Focus the lens manually.

- If the use-flash signal (▼) in the viewfinder blinks, a flash should be used; the shutter can be released without flash, but exposure may not be correct.
- After taking the picture film is automatically advanced to the next frame and the frame counter increases by one.
- When taking pictures of a moving subject, press the shutter release button all the way down without checking for the green focus signal.

Automatic film rewind

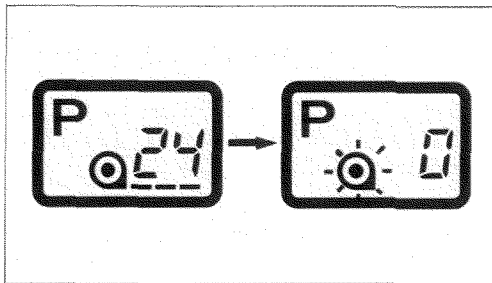

After the last frame is exposed, the camera will automatically start rewinding the film. With a fresh battery loaded in the camera, it normally takes just 12 seconds to rewind a 24-exposure film and 16 seconds for a 36-exposure film.

When the film is completely rewound the rewind motor switches off automatically. At this time the film-cartridge symbol in the data panel blinks to indicate that the film may be removed, and 0 appears in the frame counter. While rewind is in progress, the frame number of the last exposure remains in the frame counter.

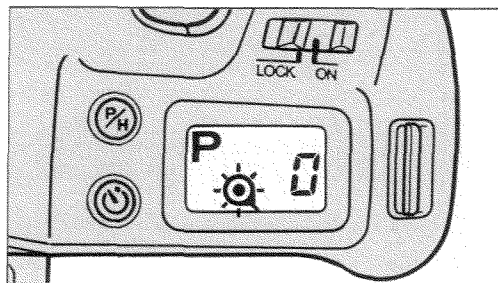

If the film cartridge is left in the camera after the film is rewound, the shutter cannot be released and the camera will beep each time the shutter-release button is pressed.

- To stop film rewind before the film is completely rewound, slide the main switch to LOCK. To restart automatic film rewind, slide the main switch to ON.

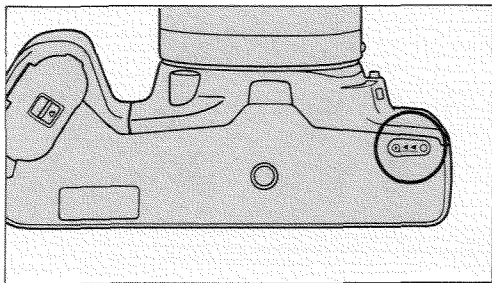

Manual start of film rewind

You can manually start film rewind when you want to remove a roll of film before the last frame is exposed. Before manually starting film rewind, check that battery power is sufficient (see page 11). Then press the rewind button (on the bottom of the camera) with a ball-point pen or similar object to start the rewind motor.

- If you accidentally open the camera's back cover before the film is rewound, close it immediately. Press the rewind button to finish rewinding the film. Light falling on the film will ruin many of the pictures, but your quick action may save a few .
- Before starting rewind you should check the battery condition indicator in the data panel. If the blinking low-battery symbol is displayed, the battery should be replaced. Although you may be able to take pictures following a blinking low-battery indication, the camera's rewind function may not be operable in this case.

Using flash

The simplest way to take top-quality flash pictures is to use either Maxxum Flash D-314i or Maxxum Flash D-316i. Designed for use with the Maxxum 3000i, either flash will slip easily into the camera's accessory shoe and then be controlled by the Maxxum 3000i's flash control system. Both flashes are powered by the camera's lithium battery and have built-in focus-assist illuminations for low light autofocusing. The flash is fired automatically and can remain attached to the camera at all times.

When the Maxxum 3000i is operated under low-light or back-light conditions, the viewfinder's use-flash signal (▼) will blink and the camera will beep; this indicates that a flash should be used to ensure correct exposure. With a Maxxum Flash attached and switched to ON, the flash will begin to charge; during flash charge, you cannot release the shutter. When the flash reaches full charge, the blinking use-flash signal (▼) will be replaced by a blinking flash-ready signal (⚡) and the camera will beep rapidly. At this stage, it is necessary to momentarily remove your finger from the shutter before pressing down again to take the picture. Following exposure, the viewfinder's flash-ready signal (⚡) will blink rapidly to indicate that exposure was sufficient. For more information about Minolta Maxxum Flashes, refer to page 32, 33.

FOCUS

Autofocus



Autofocus mode is selected by moving the focus mode switch to AF position. With the camera in autofocus mode, autofocus is activated by pressing the shutter-release button partway down.

Focus Hold

The focus remains locked on the subject as long as you keep the shutter-release button pressed partway down.

To take a picture with the subject not in the center of the frame, first press the shutter-release button partway down and focus with your subject centered in the focus frame; then,

while keeping the button pressed, recompose the picture. Press the shutter-release button all the way down to release the shutter.

Autofocus Signals

Green signal glows: Subject is in focus and shutter can be released.

Red signal blinks: Focus cannot be confirmed by camera and shutter cannot be released. Set camera to manual focus mode and turn lens' focusing ring until subject appears sharp in viewfinder.

Manual focus

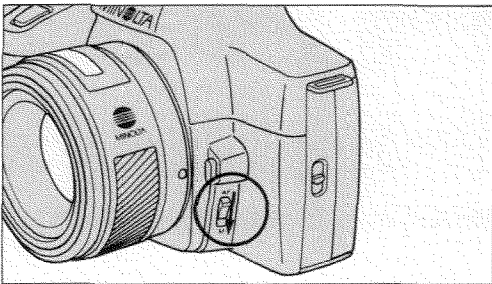

1. With focus-mode switch at M position, center focus frame on subject.
2. Press shutter-release button partway down to activate focus signals.
3. Turn lens' focusing ring until green focus signal glows. If you maintain slight pressure on the shutter-release button, the camera beeps as the subject comes into focus.

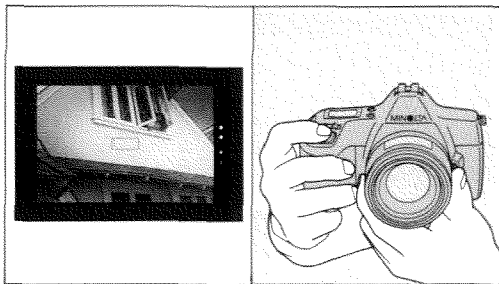

4. Press shutter-release button all the way down to take the picture.
- When using manual focus, the shutter can be released at any time, even if subject is not in focus.

Manual Focus Signals

Green signal glows: Subject in focus.

Red signal blinks: Subject out of focus. Turn focusing ring until subject appears sharp in viewfinder.

Focusing in special situations

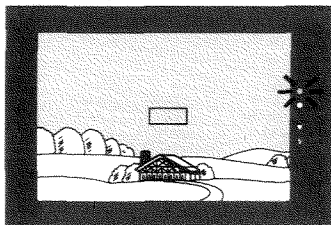

A

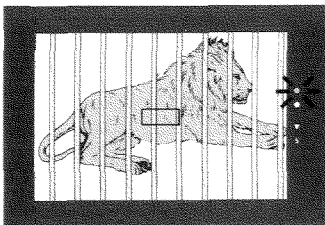

B

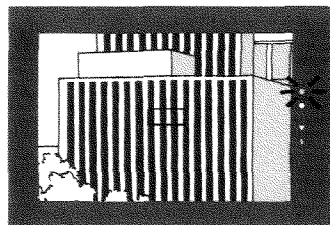

C

The camera's autofocus system will produce sharply focused pictures in nearly any situation. In some cases, additional steps should be taken to obtain sharp focus.

- If the subject is low in contrast, particularly horizontal contrast, focus manually (A).
- If an object is placed between you and your subject, focus manually (B).
- If a subject composed of alternating light and dark lines fills the focus frame, focus manually (C).
- When the light level is too low for the autofocus system to respond, attach a flash unit or focus the lens manually.
- For extremely bright subjects, attach a neutral-density filter to the lens.

EXPOSURE MODES

Program mode



Program mode is the Maxxum 3000i's normal exposure mode. Whenever the main switch is moved from LOCK to ON, Program mode is set automatically and a large letter P appears in the data panel.

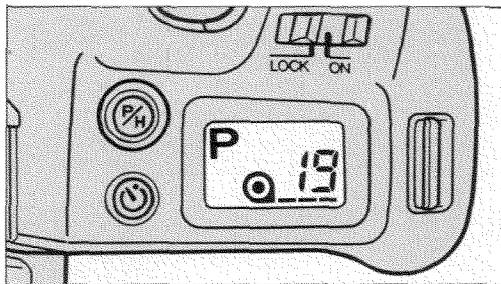

In Program mode, you just aim the camera and press the shutter-release button to take the picture. The camera automatically sets the correct exposure; no manual settings are required.

High-speed program mode



If you are taking pictures of a fast-moving subject, you may wish to select the High-speed program. This program maintains the fastest available shutter speed, so there is less chance of image blur caused by camera shake or subject movement.

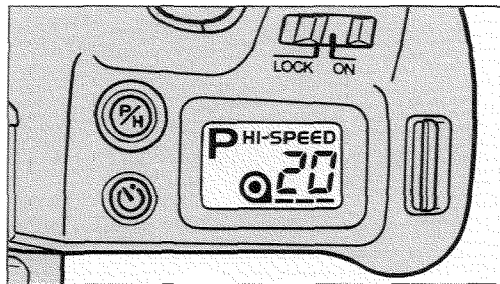

To select High-speed program mode, press the P/H button. P and HI-SPEED are displayed in the data panel. To reset the camera to its normal program, press the P/H button again. The camera automatically resets the normal program whenever the main switch is moved from LOCK to ON.

- The use-flash signal (▼) blinks in the viewfinder when flash is required for low-light or backlit subjects.

ADDITIONAL INFORMATION

Main switch

When the main switch is at ON position, all functions will operate and you can take pictures. At LOCK position, all camera functions are switched off. When you are not using the camera, set the main switch to LOCK to prevent accidental exposures and ensure optimum battery life.

When you switch your Maxxumx 3000i to ON, with a Minolta AF lens attached and the camera in AF mode, the camera's autofocus system adjusts the lens extension in preparation for autofocus operation. Similarly, when the camera is switched to LOCK, with a Minolta AF lens attached and the camera set to AF mode, the autofocus system will retract the lens to its shortest extension for ease of carrying or storage.

The top-mounted data display remains visible for about one hour after the camera was last operated or after the main switch is moved to LOCK. The display returns when the shutter-release button is pressed or the main switch is moved to ON; in either case, the camera is set to Program Mode.

- If desired, the slow shutter-speed signal may be switched off. Set the main switch to ON. Then, while holding down both the mode selector (P/H) and self-timer (⊙) buttons, move the main switch from ON to LOCK and back to ON. To switch the signal on again, repeat this procedure.

Audible signals

The camera emits short beeps in the following situations:

- When film is loaded incorrectly;
- When the subject comes into focus;
- When using the self-timer;
- If the film cartridge is left in the camera after rewinding is complete and the shutter-release button is pressed; and
- When the shutter speed is too slow for blur-free, hand-held pictures.

In this case, the use-flash signal (▼) in the viewfinder will blink as an additional warning.

With a Maxxum Flash attached and set to ON, the camera will beep rapidly once full charge is reached; in this case, the flash-ready signal (⚡) blinks as well.

Self-timer operation

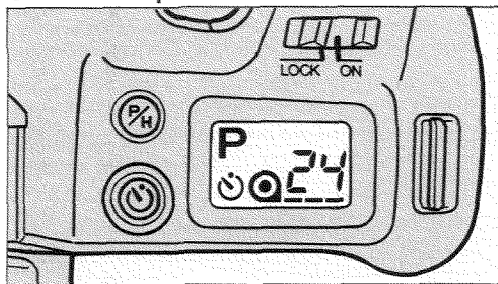

The Minolta Maxxum 3000i's electronic self-timer lets you delay shutter release for ten seconds. To use the self-timer:

1. Press the self-timer (⌚) button. The self-timer symbol (⌚) will appear in the data panel.

- At this point, pressing the button again will switch off the self-timer.

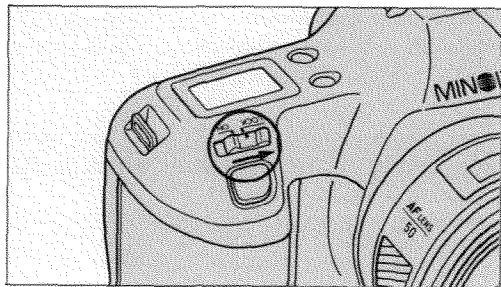
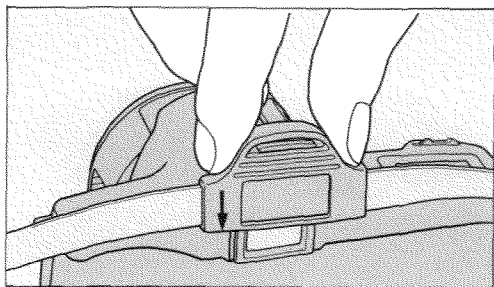

2. Focus the lens, check for the green focus signal in the viewfinder, and attach the eyepiece. Once self-timer countdown is started, autofocus will not operate.

3. Press the shutter-release button all the way down to start the self-timer.

- The camera will beep twice a second and the self-timer indicator (☺) will blink until the shutter is released.
- The self-timer is automatically switched off after the exposure. Repeat steps 1 through 3 to make another exposure using the self-timer.

To stop the self-timer:

If you have started the self-timer and want to stop it before the picture is taken, slide the main switch to LOCK.

ACCESSORIES

Minolta Maxxum Flash

Besides the Maxxum Flash D-314i and D-316i models which are designed exclusively for the Maxxum 3000i, you can also use the more powerful Maxxum Flash 3200i with your camera. These flash units attach to the camera's accessory shoe.

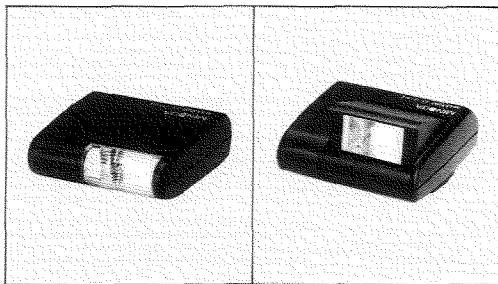

Maxxum Flash D-314i

Guide Number: 46 in feet at ISO 100

Maximum flash range: 16 ft.

AF illuminator range: 1.6 to 16 ft.

Flash coverage: 35mm or longer lenses

Power: Supplied by camera

Maxxum Flash D-316i

Guide Number: 52 in feet at ISO 100

Maximum flash range: 19 ft.

AF illuminator range: 1.6 to 16 ft.

Flash coverage: 35mm or longer lenses

Power: Supplied by camera

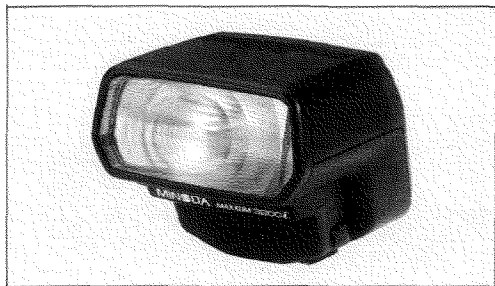

Maxxum Flash 3200i

Guide Number: 105 in feet at ISO 100 with 85mm lens

Maximum flash range: 32.8 ft.

AF illuminator range: 1.6 to 29.5 ft.

Flash coverage: Internal zoom adjusts coverage automatically for 28mm through 85mm lenses

Power: 4 AA-size alkaline or nickel-cadmium batteries

Note: Flash ranges based on Minolta standard test method with an aperture of f/2.8 or larger

Use of other Minolta Maxxum Flash Units

Other Minolta Maxxum Flash units, 4000AF, 2800AF, 1800AF, and Macro Flash 1200AF can also be used. The AF illuminators on the 4000AF, 2800AF and 1800AF will not operate, so autofocus in low light may not be possible.

Note: These flash units cannot be attached directly to the camera; the Flash Adapter Shoe FS-1100 must be used between the flash and camera.

When using Maxxum Flash 4000AF, the flash range displayed on its flash data panel may be larger than the actual maximum flash distance. If your subject is close to the maximum distance, it could be underexposed. Correct exposure is confirmed by the glowing "OK Exp" signal; confirmation of exposure is also given by rapid blinkings of the flash-ready signal in the camera's viewfinder.

Maxxum AF Lenses

The entire system of Maxxum AF lenses are usable with the Maxxum 3000i camera. Besides the ergonomically designed, compact AF 35-80mm and AF 80-200mm zoom lenses, a growing range of wideangle, standard, telephoto, zoom, and macro lenses is available. Visit your Minolta dealer for more information about Maxxum AF lenses and accessories.



Data Back DB-3

The Data Back DB-3 permits imprinting of the date, day with 24-hour time, or the hour and minute of exposure. A single 3-volt lithium battery is installed at the factory and supplies power for data imprinting, automatic calendar, and clock.

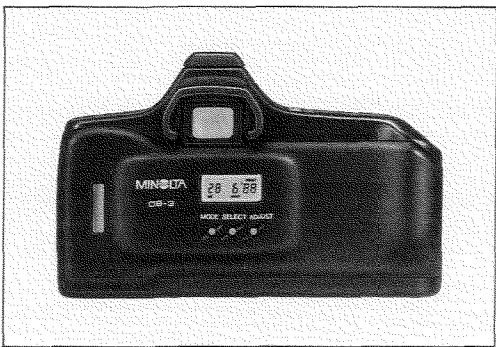

Camera case

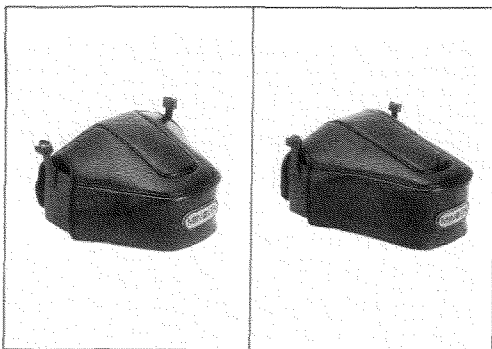
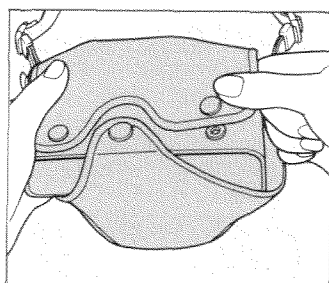
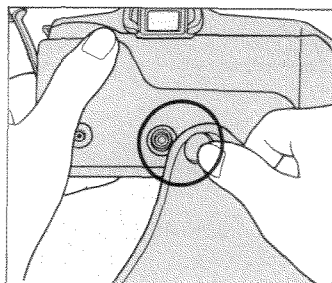
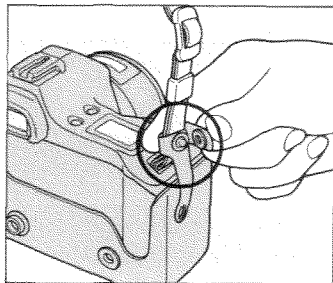

CH-300

CH-300L



Various camera cases are available as optional accessories for the Minolta Maxxum 3000i.

To put the camera in its case:

1. Attach lens cap. (If using the AF 35-80mm or AF 80-200mm lens, close its lens cover.)
2. If using a zoom lens, turn zoom ring until lens barrel is at its shortest position.
3. Follow the diagrams to put camera into case.

TROUBLE SHOOTING GUIDE

Problem	Cause	Solution
No display appear on LCD panel.	Battery is exhausted. Battery is not installed correctly.	Install fresh battery. Install battery correctly.
Frame counter does not advance from "0".	Film is not loaded correctly	Open back cover and reload film.
Focus is not adjusted when taking flash pictures.	Distance to the subject is too far or too short. Subject's reflectivity is too low for autofocusing. Focus length of lens is greater than 100mm.	Check that the subject is within the focus illuminator's range. Focus on a subject that is same distance away as the main subject. Change to manual focusing.
Autofocus does not work or lens does not focus when shutter-release button is pressed.	Lens is not attached correctly. Focus mode switch is at M position Subject is difficult to focus. Zooming grip is positioned macro range.	Attach the lens so it locks in place with a click. Slide the focus mode switch to AF position Use focus lock or manual focus. Slide and hold macro release, then turn zooming grip back into zoom range.

Problem	Cause	Solution
Flash-ready signal () in the viewfinder does not appear.	Flash's power switch is at OFF position. Flash is not attached to camera correctly.	Switch flash unit on and check that flash signal in viewfinder blinks. Attach the flash to the camera's accessory shoe so that it locks in place with a click.
When shutter-release button is pressed, LCD disappears and camera does not operate.	Battery is exhausted.	Install fresh battery.
Shutter cannot be released	Main switch is at LOCK. Film cartridge remains in camera after film is completely rewound. Flash is not fully charged. Film loaded incorrectly In AF mode, focus cannot be confirmed	Slide the main switch to ON. Remove the film cartridge from the camera. Wait until the flash-ready signal() blinks, lift your finger from the shutter-release button, then press down fully to take the picture. Reload film. Switch to M mode and focus manually.

TECHNICAL DETAILS

Type: 35mm SLR with intelligent control of autofocus (AF), autoexposure (AE), and auto film transport systems

Lens mount: Minolta A-type bayonet; accepts all Minolta AF lenses

Autofocus system: Minolta's through-the-lens (TTL) phase-detection type with wide charge-coupled device (CCD) sensor; sensitivity range: EV 0 to 18 at ISO 100 in ambient light

Manual focusing: By referring to focus signals in viewfinder, or visually on Acute-Matte viewfinder screen

Metering: TTL dual-area contrast-detection metering coupled to autofocus system; exposure locked when focus is locked in autofocus mode; center-weighted metering when using manual focus mode; two-segment silicon photocell (SPC) for ambient light; second SPC at bottom of mirror box for TTL flash metering with dedicated flash units

Auto-exposure (AE) range: EV 1 to 20 with ISO 100 film and 50mm f/1.4 lens

Exposure modes:

Program AE: Advanced automatic multi-program selection of shutter speed and aperture based on focal length of lens in use

High-speed Program AE: Shutter speed set to approx. 1/1000 sec. until slower shutter speed is required for correct exposure; aperture set automatically based on ambient light level

TTL flash metering: Operates with dedicated units; automatic charge activation when flash is required; shutter X-sync speed set automatically from 1/60 to 1/20 sec. according on focal length of lens in use; aperture setting based on ambient light level

Shutter: Electronically controlled vertical-traverse focal-plane type; range: 1/1000 to 4 seconds

Controls: Buttons to choose between standard or high-speed program, set self-timer operation, and manually start film rewind

Shutter-release button: In autofocus mode, pressing button partway down activates autofocus and metering systems and locks focus and exposure on subject; pressing button all the way down releases shutter; shutter can be released only when subject is in focus (focus-priority shutter release)

Film-speed settings: Automatic setting for DX-coded films; range: ISO 32 to 3200 in ambient light, ISO 32 to 1000 for TTL flash metering; film speed set to ISO 100 for film without DX coding

Film transport: Auto threading, auto advance to first frame, single-frame advance, advancing frame counter in data panel; auto rewind or manual start of rewind

Viewfinder: Eye-level fixed roof mirror shows 90% of field of view; magnification 0.75X with 50mm lens at infinity

Data displays:

Data panel: Liquid-crystal display (LCD) shows exposure mode, frame number, self-timer operation, and battery condition

Viewfinder: Light-emitting diodes (LED) signal focus status, use-flash, flash ready, and sufficient flash exposure

Power: 6-volt 2CR5 lithium battery powers camera (and Maxxum Flash D-314i or D-316i, if attached); battery condition indicated by four-stage indicator in data panel; shutter locks when battery is exhausted; sliding main switch has LOCK and ON positions

Battery performance: Approximately 55 rolls of 24-exposure film without flash and 25 rolls of 24-exposure film using flash D-314i on 50% of the exposures.

Audible signals: With main switch at ON position, camera beeps if film is loaded incorrectly, when subject comes into focus, during self-timer operation, as a slow shutter speed warning, when flash reaches full charge, and when film is left in camera after rewinding is complete.

Self-timer: Electronic with 10-second delay; cancelable; operation indicated by audible signal

Other: Eyepiece Cup EC-3, eyepiece cap, carrying strap, film window

Size and weight: 5-9/16 x 3-1/2 x 2-3/8 in. (142 x 88.5 x 60.5mm), 14-13/16 oz. (420g) without lens and battery

Optional accessories: Accepts all Minolta AF lenses, Maxxum Flashes D-314i, D-316i and 3200i, Data Back DB-3, Eyepiece Correctors, and flash accessories including off camera cables and connectors

CARE AND STORAGE

- Always keep your camera in its case with the lens capped when not in use, or with a body cap on when a lens is not attached.
- No part of the camera should be forced at any time.
- Never subject your camera to shock, high heat, high humidity, water, or harmful chemicals. Be particularly careful not to leave it in the glove compartment or other places in motor vehicles where it may be subjected to high temperatures.
- Entry of sand, salt, or other grit may cause costly or irreparable damage to the camera. Use extra care when taking pictures at the beach.
- Never lubricate any part of the camera body or lens.
- Never touch the shutter curtains, mirror, or the front inside parts of the body or clean them with compressed air. Doing so may impair their alignment and movement.
- External camera surfaces and lens barrel—but not glass surfaces—can be cleaned by wiping with a dry or silicone-treated cloth.
- Never touch lens or eyepiece surfaces with your fingers. Whisk away loose matter with a blower brush. To remove stubborn spots, use a sheet of photographic lens tissue. If necessary, tissue may be moistened with one drop of lens-cleaning fluid. Never place fluid directly on glass surfaces.
- We recommend that you have your camera cleaned once a year at an authorized Minolta service facility.
- If you plan to store your camera for an extended period of time, rewind and remove the film, then remove the battery. Place the camera in a cool, dry place away from dust or chemicals, preferably in an airtight container with a drying agent such as silica gel.

- After prolonged storage, and especially before taking pictures at an important event, carefully check the operation of the camera and lens.

- The operating range for the LCD (liquid crystal display) data panel is from 14° to 122°F (−10° to 50°C). At temperatures outside this range, response time and contrast will change, making displays difficult to read. At very high temperatures, a display may temporarily darken. If this occurs, the display should return to normal after the camera is restored to operating range conditions.

- The Maxxum 3000i contains no user-serviceable parts. Do not attempt to disassemble or repair the camera yourself.

- The Maxxum 3000i's circuitry may switch off, even when a battery with sufficient power is installed. To resume operation, remove the battery and install it again.

Save camera box and packing material. When shipping your camera, carefully repack it in the box, insure adequately, and use a reliable delivery service.

Before shipping your camera for repairs, contact your nearest authorized Minolta service facility.



STATEMENT OF FCC COMPLIANCE

This device complies with Part 15 of the FCC Rules. Operation is subject to the following two conditions: (1) This device may not cause harmful interference, and (2) this device must accept any interference received, including interference that may cause undesired operation. Changes or modifications not approved by the party responsible for compliance could void the user's authority to operate the equipment. This equipment has been tested and found to comply with the limits for a Class B digital device, pursuant to Part 15 of the FCC rules. These limits are designed to provide reasonable protection against harmful interference in a residential installation. This equipment generates, uses and can radiate radio frequency energy and, if not installed and used in accordance with the instructions, may cause harmful interference to radio communications. However, there is no guarantee that interference will not occur in a particular installation. If this equipment does cause harmful interference to radio or television reception, which can be determined by turning the equipment off and on, the user is encouraged to try to correct the interference by one or more of the following measures: Reorient or relocate the receiving antenna.

Increase the separation between the equipment and receiver.
Connect the equipment into an outlet on a circuit different from that to which the receiver is connected. Consult the dealer or an experienced radio/TV technician for help.

STATEMENT OF DOC COMPLIANCE

This digital apparatus does not exceed the Class B limits for radio noise emissions from digital apparatus set out in the Radio Interference Regulations of the Canadian Department of Communications.

Minolta Camera Co., Ltd.

3-13, 2-Chome, Azuchi-Machi, Chuo-Ku, Osaka 541, Japan

Minolta Corporation

Head Office

101 Williams Drive, Ramsey, New Jersey 07446, U.S.A.

Los Angeles Branch

11150 Hope Street Cypress, CA 90630, U.S.A.

Chicago Branch

3000 Tollview Drive, Rolling Meadows, IL 60008, U.S.A.

Atlanta Branch

5904 Peachtree Corners East, Norcross, GA 30071, U.S.A.

Minolta Canada Inc.

Head Office

369 Britannia Road East, Mississauga, Ontario L4Z 2H5, Canada

Montreal Branch

3405 Thimens Blvd., St. Laurent, Quebec H4R 1V5, Canada

Vancouver Branch

105-3830 Jacombs Road, Richmond, B.C. V6V 1Y6, Canada

Minolta GmbH

Kurt-Fischer-Strasse 50, D-2070 Ahrensburg, Germany

Minolta France S.A.

365-367 Route de Saint-Germain, 78420 Carrieres-Sur-Seine, France

Minolta (UK) Limited

1-3 Tanners Drive, Blakelands North, Milton Keynes, MK14 5BU, England

Minolta Austria Gesellschaft m.b.H.

Amalienstrasse 59-61, 1131 Wien, Austria

Minolta Camera Benelux B.V.

Zonnebaan 39, 3606 CH Maarssenbroek, P.B. 264, 3600 AG Maarssen, The Netherlands

Belgium Branch

Kontichsesteenweg 38, B-2630 Aartselaar, Belgium

Minolta (Schweiz) AG

Riedhof V, Riedstrasse 6 8953 Dietikon-Zürich, Switzerland

Minolta Svenska AB

Brännkyrkagatan 64, Box 17074, S-10462 Stockholm 17, Sweden

Minolta Portugal S.A.

Av. do Brasil 33 a, 1700 Lisbon, Portugal

Minolta Hong Kong Limited

Room 208, 2/F, Eastern Center, 1065 King's Road, Quarry Bay, Hong Kong

Minolta Singapore (Pte) Ltd.

10, Teban Gardens Crescent, Singapore 2260



MINOLTA